













# ASSEMBLY INSTRUCTIONS

Thank you for purchasing this quality product from F.A.M.E. Industries. Place all parts on a clean and smooth surface such as a rug or carpet to avoid the parts from being scratched. Be sure to check all packed material carefully for small parts which may have come loose inside the carton during shipment. In the even that you find any hardware missing (screws , dowels, buttons.) please call our customer service at 1-877-GO 4 FAME. We will PROMPTLY ship you via overnight mail the missing hardware. We hope you find our product "Simply-Simple" to assemble, and welcome your comments to MyFAMEexperience@simply-simple123.com.

HARDWARE LIST			
NO	DESCRIPTION	SHAPE	QTY
1	5656/5570 QUICKFIT (WITH CAP)		7 SETS (*)
2	M6 X 50MM JCBC SCREW (BLACK)		7 PCS (*)
3	M3.5 X 16MM CHIPBOARD SCREW		21 PCS (*)
4	PVC SQUARE LEG (WITH CAP)		5 SETS
5	M4 ALLEN KEY		1 PC
6	M8 X 25MM WOOD DOWEL		21 PCS (*)
7	WIRE CAP 60MM (WITHOUT COVER)		2 PCS

**\* HARDWARE**  
1 PC EXTRA INCLUDED

PARTS LIST		
NO	DESCRIPTION	QTY
A	TOP PANEL	1
B	SIDE PANEL - L	1
C	SIDE PANEL - R	1
D	CENTER PANEL	1
E	FIX SHELF PANEL	2
F	BOTTOM PANEL	1
G	BACK PANEL	2

HARDWARE NO 1	
<b>1**</b>	
	HOLE
<b>1*</b>	 STEP 1 UNLOCK
	STEP 2
<b>1***</b>	 STEP 3 LOCKED
<b>DETAIL</b>	

## FIX HARDWARE ON PARTS

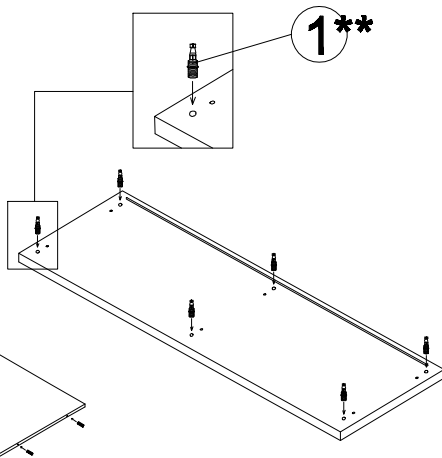
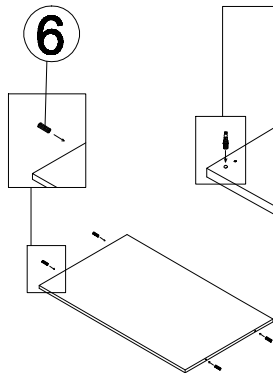
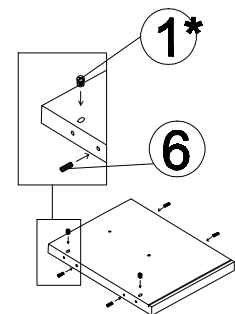
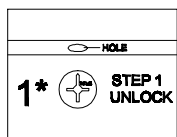

B, C, D

E

A

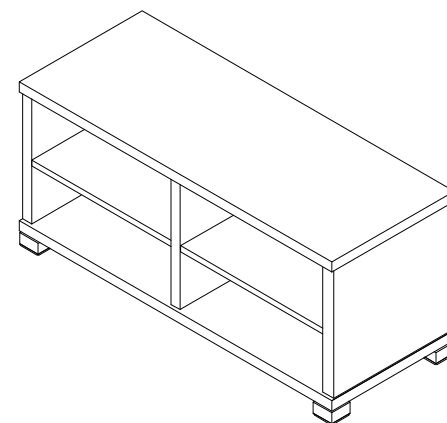

TV STAND

## STEP 1

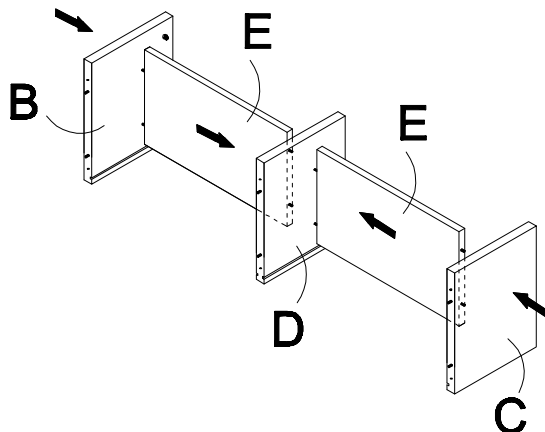

**STEP 2**

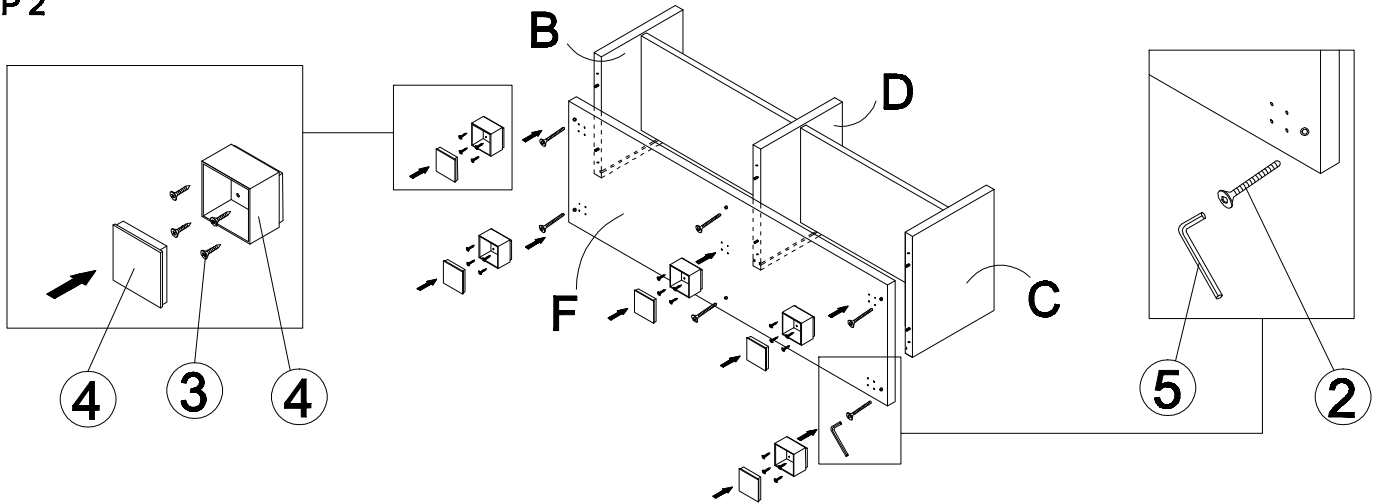

**FIX BOTTOM PANEL - F , THEN FIX THE LEG - 4**

**STEP 3**

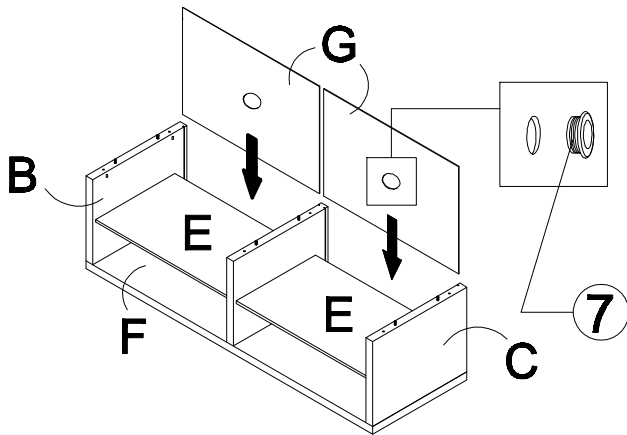

**INSERT REAR PANEL**

**STEP 4**

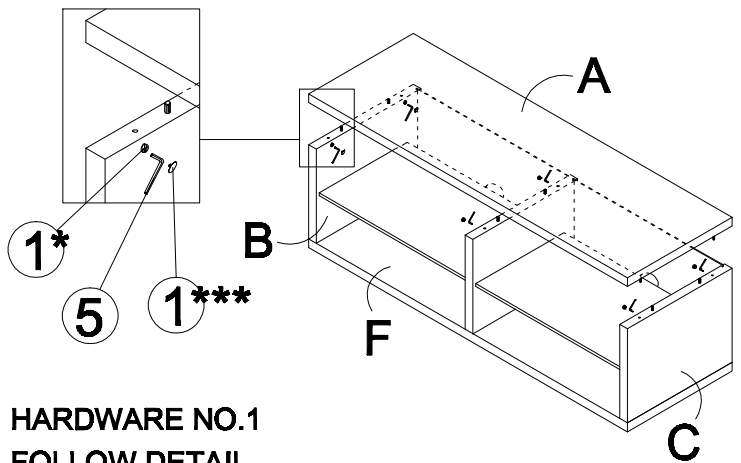

**HARDWARE NO.1  
FOLLOW DETAIL**

**STEP 5**

**TIPPING RESTRAINT KIT**

NO	DESCRIPTION	SHAPE	QTY
8	#8 X 1" PAN HEAD SCREW		1 PC
9	#8 X 5/8" PAN HEAD SCREW		1 PC
10	U-BRACKET		2 PCS
11	WALL PLUG		1 PC
12	TIE STRAP		1 PC

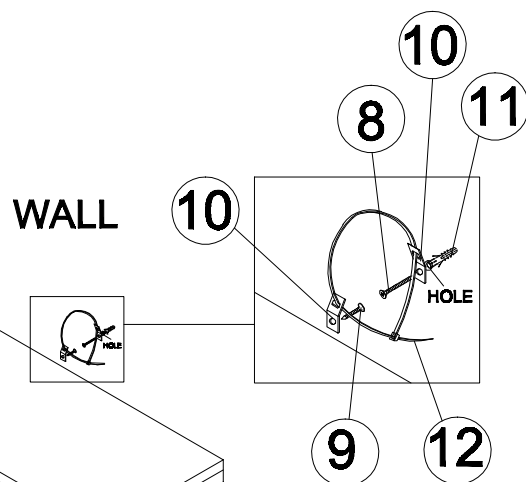

**FIX TIPPING RESTRAINT KIT**

**MADE IN MALAYSIA  
( # 40 - 07 )**